

# DEVELOPMENT OF MODELING TOOLS FOR OPTIMAL DESIGN, CONTROL AND DIAGNOSIS OF SOLID OXIDE FUEL CELL APUS

Pianese, C., Sorrentino, M.

---

DIMEC, University of Salerno, Italy  
[pianese@unisa.it](mailto:pianese@unisa.it), [msorrentino@unisa.it](mailto:msorrentino@unisa.it)

Received September 2009, Revised November 2009, Accepted February 2010

## Abstract

The Solid Oxide Fuel Cell (SOFC) is nowadays one of the most promising fuel cell technologies, due to a number of positive features, such as high energy conversion efficiency and fuel flexibility. Nevertheless, the actual technological stage pushes the researchers towards the establishment of specific tools and standards to speed-up the transition to SOFC commercialization into a wide application area, ranging from automotive to marine and airplane Auxiliary Power Units (APUs). Particularly in this work, an overview is given on control-oriented modeling of SOFC at both single cell and stack level. Both numerical results and physical considerations, provided throughout the paper, highlight the importance of developing model-based tools for enhancing design phases, as well as the definition of reliable control and diagnostics strategies for SOFC-APUs.

**Keywords:** Fuel cell, control, modeling, design, energy

## 1. Introduction

Nowadays the development of clean energy systems, for both automotive and stationary applications, is recognized as mandatory to satisfy well-known environmental and regulatory requirements in terms of emissions and energy conversion efficiencies. Because of their high efficiencies and zero toxic emission levels (only the CO<sub>2</sub> released by the hydrogen production process is a concern) fuel cell systems are considered as the most attractive solution by the Automotive and Power Generation industry, and by many research/academic organizations (e.g. EU and USA agencies). In these contexts, solid oxide fuel cells are gathering particular appeal, due to their high efficiencies, modularity, fuel flexibility, on one hand, and low emissions and noise on the other [1-3]. Moreover, the high working temperatures provide additional positive features, such as potential use of SOFC in highly efficient cogeneration applications [3]. SOFCs also are suitable for internally reforming the fuel (e.g. natural gas, propane, methanol, gasoline, Diesel, etc.), thus allowing to avoid the adoption of highly sophisticated, expensive external reformer and simplify fuel storage [2]. Nevertheless, the big challenges to promote SOFC systems diffusion are mainly

related to production costs and durability. Among others, the Solid state and Energy Conversion Alliance (SECA) is one of the most noticeable research platforms involved in SOFC development. Particularly, they jointly defined a ten-years program aimed at developing a low-cost, 10 kW module, flexible enough to be applied to transportation, APUs and stationary power plants. The achievement of such an objective will surely contribute to promoting the technology and finally starting a mass production phase. Once this goal is reached, potential areas of application in the short term will be small residential power generators and vehicles' APUs. In the long term scenario, SOFC applications could be reasonably extended to marine, rail and airplane APUs, high-power stationary generators and even to marine and rail propulsion [4].

Regarding the other key aspect, i.e. stack durability, it is well known that actual SOFC system prototypes suffer from a low reliability of both the fuel cell itself and the complete system, not allowing a commercial deployment of such systems. At the actual stage, system state of health can hardly be evaluated, making it difficult to handle faults or degradation with an appropriate counter measure. That's the reason why cooperative work on SOFC modeling, control and diagnostics is now strongly encouraged by international research organizations, such as the European N. Ergy [5].

## 2. Major areas of application for SOFCs

The majority of recent press communications and scientific publications available on the public domain addressed PEMFC and SOFC as the most promising fuel cell technologies. Particularly, PEMFC appears to be as the most suitable for transportation applications, whereas SOFC claims higher potentialities in the often-joint fields of stationary power and on-site cogeneration [6].

SOFC application to residential plants is today under fast development, due to the intrinsic features of this fuel cell type. High operating temperatures bring two strong motivations for such a trend: slow dynamic response and high-temperature wasted heat. The former slows down the interest for automotive propulsion uses, due to the highly fluctuating power demands. The latter, instead, significantly

promotes the use of SOFCs in Combined Heat and Power (CHP) plants, as well as their implementation in hybrid stationary plants, such as SOFC & gas turbine [7] or SOFC & stirling engines [8].

But SOFCs are characterized by another important advantage, as compared to the other fuel cell types: the high fuel flexibility. Of particular interest is their suitability to be operated with reformat feeds, obtained by pre-reforming several fuel sources, such as methane, buthane, propane, methanol, gasoline and diesel. In fact, SOFCs could be directly fed with non-reformat fuels, letting them be internally reformed inside the cell, thanks to the high temperatures. Nevertheless, at the current development-stage, it is suggested to partially pre-reform the fuel to avoid cell over-cooling, which otherwise might cause unacceptable, dangerous thermal stresses to the solid parts [9].

As a consequence of their high fuel flexibility, many researchers are really considering the use of SOFCs for transportation application, especially to face well known issues associated with on-board storage of H<sub>2</sub>. Particularly, as outlined by SECA [1], SOFCs are currently being preferred with respect to PEMFC for automotive auxiliary power units [10].

SOFC-APUs are usually assembled into a hybrid configuration, in which the fuel cell stack interacts with the auxiliary components to match the load request. A simple schematic of a reformat-fed automotive APU is given in Figure 1, where a considerable number of devices to assist stack operation is required.

Potential automotive applications of the APU module shown on Figure 1 include:

- Mild hybrids: SOFC supplies electric and thermal energy for hotel functions when the engine (ICE) is turned off.
- EV range extender: SOFC recharges battery during trip to extend battery autonomy. SOFC is operated steadily at its maximum efficiency depending on driving conditions.
- Full Hybrid: SOFC supports ICE in powering the vehicle, allows to reduce battery size and replaces the engine in urban driving.

At the end of this general overview on SOFC applications, it is worth mentioning that the experience gained through mobile APU development could be reasonably re-scaled and then extended to rail and marine propulsion; in these fields power demands are less fluctuating than automotive ones.

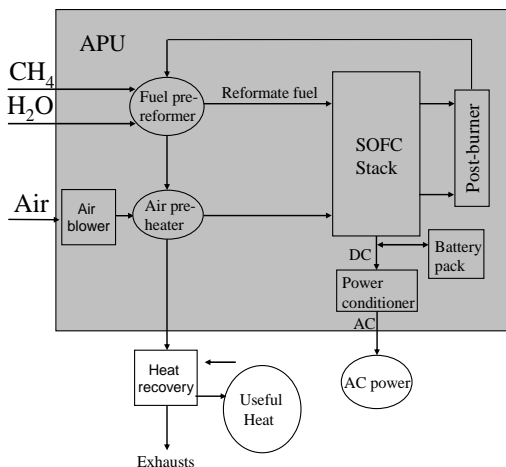

**Figure 1: Typical schematic representation of an SOFC-APU.**

### 3. Research Needs

Specific research needs to be met for short term implementation of SOFC include the following:

1. Low temperature operations.
2. Optimal cell configuration.
3. Optimal Balance of Plant (BoP), Control.
4. Production Standardization.
5. Failure/degradation prevention.

Particularly, letting SOFC work at lower temperatures would surely enhance technological feasibility, with the draw-back of lowering efficiencies too. Thus, the optimal temperature range has to be found as the best trade-off between material specifications and efficiencies. Lower temperature operations can be achieved either by using innovative electrolyte materials (i.e. gadolinia-doped ceria) or building electrode supported cells [9]. Moreover, the cell design has to be chosen in such a way as to maximize system efficiencies and reduce the risk of components damage. Planar designs have lower electrical resistance than tubular, thus resulting in higher energy conversion efficiency and, in turn, higher specific power [2]. Regarding gas-feeding, co-flow ensures a more even temperature distribution in the flow direction as compared to counter-flow, which is instead characterized by dangerous thermal mismatches that might damage the ceramic components [11]. Thus, choosing a planar co-flow configuration positively impacts production costs and feasibility.

Design and system sizing require the development of computational tools suitable to describe SOFC behavior in both steady and transient conditions. Steady-state models serve at important aims, such as improving knowledge of internal processes occurring inside the SOFC, individuating the optimal operating set-points and determining stack size as function of nominal power demand. On the other hand, modeling SOFC dynamics is a key requirement for even more crucial aspects. Prediction of SOFC response to load change allows evaluating the thermal stresses imposed to cell components during transients. Therefore, selection of materials, components design and control strategies definition are enhanced. Correct sizing of auxiliaries components, such as energy storage devices (battery, super capacitors), require accurate estimation of SOFC power to meet load demands during peak-power phases. Moreover, to enhance production standardization, it is needed to implement computational tools that meet the conflicting needs of accuracy, affordable computational time, limited experimental efforts and flexibility. The availability of such tools might also enhance balance of plant and definition of optimal control and diagnostics strategies for hybridized APU [10].

As far as point 5 is concerned, current system-level control and stack degradation prevention are based on pre-evaluated temperature, pressures and gas composition limits. However, as stack internal behavior and gas/temperature/current distribution can change drastically (e.g. with different gas compositions and fuel utilization rates), a pre-determined limitation can be based only on few selected points. In SOFC systems the operating conditions may vary significantly during the operational life-time on average. In large-scale systems, where there are several stacks, there may be also some differences between one stack and another. In order to optimize the control actions and degradation prevention capabilities, specific diagnostic methods are needed to determine the actual state of the stacks in real-time.

#### 4. Literature Review

The availability of steady-state models, ranging from 3-D, CFD solver-based to 0-D (i.e. lumped) approaches, is considerable, as documented by the high number of publications available in the open literature [3,11,12]. In some of these contributions, appreciable matching with experimental polarization curves also were reported. On the other hand, at the time there is no such availability of detailed information about current and temperature distributions across the gas channels.

Regarding transient simulation, the number of publications devoted to SOFC dynamic modeling is much lower, thus clearly indicating that the field requires significant contribution yet. The pioneer work of Achenbach, who first developed a 3-D dynamic model of planar SOFC [13], showed that SOFC responds with voltage undershoot to load (i.e. current density) step changes. Moreover, in that paper it was observed that voltage relaxation time, which is of the order of hundreds of seconds at nominal current range, directly correlates with maximum cell temperature and final current density achieved after load step.

After Achenbach's work, other studies utilizing either 2-D or 1-D approaches were performed. All of them came up with conclusions similar to those exposed by Achenbach, thus giving substantial support to his basic hypotheses and methodology. In the paper of Aguiar et al. [14], voltage response of SOFC was simulated when temperature rise across the cell is controlled by PI controller. Despite sufficient validity of results was proven, a concerning drawback of the models mentioned above is that they are highly computational intensive. This is in contrast with the requirements of SOFC manufacturers and developers. Furthermore, the definition of the optimal control strategies for SOFC hybridized power units, as it is for the majority of engineering applications, can be hardly pursued without recurring to less computational intensive models.

Interesting lumped approaches were followed by Sedghisigarchi and Feliachi [15] and for control of SOFC-based distributed generators [16]. Nevertheless, in their approaches an average cell temperature was assumed as state variable, thus not allowing to provide some basic information for balance of plant analysis, such as temperature of exhaust gases (i.e. outlet SOFC temperature).

It is worth remarking that, if several steady-state experiments are available on the public domain, a lack of adequate transient experiments is noted [3]. Such data are tremendously important to enable further validation of model-based intuitions, as well as to identify control-oriented models based on lumped approaches. Therefore, the development of reliable and low-cost SOFC-based energy systems requires defining aim-oriented modeling methodologies. Also design of experiments (DOE) plans, along with setting-up specific experimental facilities to perform SOFC transient tests are needed.

Some contributions also are available concerning modeling, sizing and control of the SOFC stack and its ancillaries. Lu et al. [17] proposed a model to describe thermal and mass transfer dynamics inside a hydrogen-fed standalone SOFC-APU with assigned specifications. With this model they analyzed the heat-up phase and simulated the dynamic behavior of SOFC during a load transient, providing some useful indications on thermal management. The contribution from Lin et al. [18] deals with the development of a simplified dynamic model for an automotive hydrogen-fed SOFC-APU assisted by the thermal engine during the heat-up phase. Moreover, they

proposed sliding mode control techniques to speed-up system warm-up. Lutsey et al. [19] utilized a gasoline-fed SOFC-APU steady-state model to demonstrate the high potential offered by SOFC technology to reduce fuel consumption for commercial trucks, particularly during parked idling phases. In their work they also addressed the need for a proper design of the SOFC system and battery pack to improve thermal management and power demand matching. Of particular interest are also the experimental activities conducted by Lawrence and Boltze [20]; they showed that the burner of a catalytic partial oxidation (CPOX) reformer is suitable to perform "safe" heating-up of the SOFC stack. Hansen et al. [21] conducted hardware-in-the-loop (HIL) testing of automotive SOFC-APUs developed at Topsoe laboratories. Their analyses show, on one hand, the opportunity of reducing component development costs by recurring to HIL and, on the other, the significant fuel savings achievable by equipping commercial trucks with SOFC-APUs. Such experimental works clearly evidenced how the most realistic SOFC-APU configuration requires an external reformer to process hydrogen rich fuels. Moreover, they stressed the importance of performing optimal balance of plant and defining proper control strategies. The aim of these strategies is to prevent the stack from thermal stresses-caused damages and to enhance power demand matching during heat-up phases.

Regarding fuel cell diagnosis, different methodologies for FC stacks or electrochemical energy sources have already been presented. Some of them are model-based [22, 23], others are based on electrochemical impedance spectrometry (EIS) [24]. This latter methodology is particularly suitable for a better understanding of physicochemical phenomena that are taking place in the FC and for the parameter determination of a FC equivalent circuit description. However, until now, most of these diagnosis approaches have only been applied to low-temperature PEM fuel cell stacks or systems. The question is still open for SOFC systems.

Since the theoretical studies previously reviewed did not completely address such key issues, the modeling approach followed and the objectives pursued in this paper can give a contribution to the field.

#### 5. Modeling Approach

Nowadays, engineering research is always based on the mathematical representation of the physical system under-investigation. Modeling approaches vary depending upon the specific application field, as shown on Table 1. As expected, high physical content is required to improve component design. Regarding system sizing and optimal-control strategies definition, black-box and gray-box models are both more suitable than physical, high computational intensive models. Optimal balance of plant can be achieved adopting large-scale design optimization algorithms, which usually require several function evaluations [25]. Therefore, the use of models with a good compromise between accuracy and computational burden must be stressed.

Optimal control strategies are defined at both supervisory (i.e. high-control level) and low-control level [26]. The definition of the optimal working set-points, which competes to higher-control levels, does not necessarily require dynamic simulations. On the other hand, low-level controls are often accomplished via feedback strategies, thus requiring to take into account the main system dynamics. In both cases, optimization analyses have to be performed, thus suggesting

the combined use of steady and dynamic gray/black-box models.

Figure 2 shows the qualitative variation of required experimental burden as function of physical content. It is reasonable to expect that physical models require relatively few experimental data for their validation. On the other hand, black-box approaches entail performing a high number of experiments to be used for both identification and test. Therefore, experimental burden has to be accounted for as a further conflicting need in the trade-off analysis on modeling approach. Such issue can be addressed by recurring to a hierarchical approach. Particularly, the use of physical models can be optimized, in that once tested for validation with a reduced amount of experimental data, they can be used as virtual-experiments generators. In such a way, the available reference data sets can be extended and then, following the hierarchical sequence shown in Figure 3, black-box models can be identified and validated without further impact on experimental burden.

### 5.1 Hierarchical Modeling

The hierarchical approach proposed in this paper is sketched in Figure 3. The levels 1), 2) and 3) are representative of the different physical content. At the highest level (i.e. 1) is the real system. For the purposes of the present work, an anode supported SOFC, experimented by the Pacific Northwest National Laboratory, was chosen [12]. The corresponding polarization curves were used in this paper to develop a one dimensional steady-state model (task 1), which is placed at level 2). Thanks to its sufficiently high physical content, such model is suitable to simulate planar co-flow SOFCs for both anode- and electrolyte-supported. Moreover, both pure H<sub>2</sub> and reformat fuel feeds can be considered.

**Table 1: Modeling approaches vs. application fields.**

Modeling Approach	Application fields		
	Component Design	System Sizing	Optimal Control Strategies
Physical	X		
Steady gray/black-box		X	X
Dynamic gray/black-box		Possible	X
Hybrid Modeling	Not applicable	Appropriate combination of different approaches	

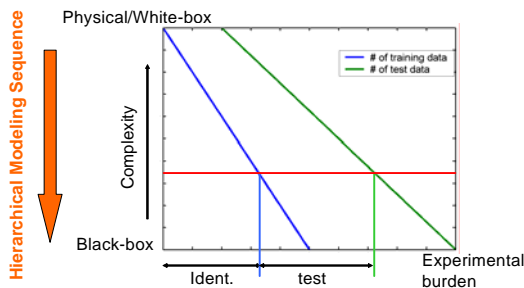

**Figure 2: Qualitative description of the impact had by modeling approach on required experimental burden.**

Standing the dominance of thermal dynamics in SOFC transient behavior, mass transfer and electrochemistry

processes can be safely assumed instantaneous [13]. Therefore, voltage dynamics was modeled applying the first principle of Thermodynamics to a lumped cell unit. To account for the influence of temperature on SOFC voltage during transients, the hierarchical sequence shown in Figure 3 was applied. The physical model (i.e. one dimensional) was used to extend the reference data-sets, with the final aim of identifying suited black-box relationships for SOFC voltage estimation. Such relationships were embedded in the dynamic equation, yielding a control-oriented model for simulation of planar co-flow SOFCs (i.e. task 2). Such model, due to its low physical content, is placed at the bottom level (i.e. 3) of the hierarchical structure. Task 3 focuses on the development of a comprehensive model of an automotive SOFC-APU. Afterwards, through task 5 the supervisory and low-level control strategies, developed via model-based approaches (i.e. task 4), are intended to be validated on a real system. The final objective (i.e. task 6) is to provide useful methodologies and tools for improving both design and control of automotive APUs.

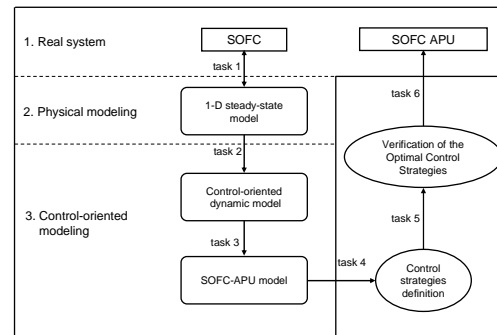

**Figure 3: Hierarchical approach for modeling (tasks 1, 2), simulation (task 3), control strategies definition (tasks 4, 5) and implementation (task 6) of an SOFC-APU.**

### 6. SOFC simulation and model-based analyses

According to the activities sequence depicted in Figure 3, the first step followed by the authors was the development of a high-level, 1-D, physical model of SOFC [27]. Such 1-D model is placed at the highest modeling level of the hierarchical structure. Figure 4 demonstrates the accuracy guaranteed by the one dimensional model in predicting cell voltage as function of operating current and temperatures. Figure 5 shows the current and temperature distribution yielded by the model for a selected operating condition in terms of current load and inlet gas temperatures. Therefore, the one dimensional model is suitable to perform “virtual experiments” for a given SOFC unit, thus enlarging the data-set available for the definition of low-level non-physical models (i.e. black-box models). In such a way, one of the key requirements in SOFC development can be met: the definition of modeling methodologies aimed at reducing the experimental burden. Then, the availability of an extended data-set allowed developing a control-oriented model with low computational burden and satisfactory precision [27]. Figure 6 shows the response of stack voltage to a step variation in current demand. Particularly, the model is capable of well capturing the voltage undershoot subsequent to such a load change, in accordance to the indications provided by high computational-intensive, multi-dimensional models [13,14]. Therefore, SOFC dynamics can be simulated guaranteeing a satisfactory compromise between computational burden and prediction accuracy.

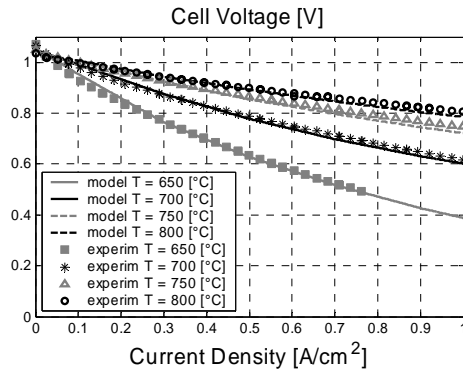

Figure 4: Comparison between simulated and experimental SOFC voltage.

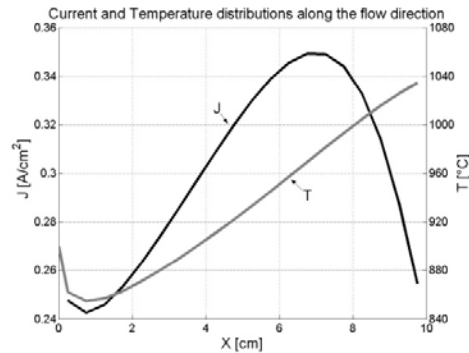

Figure 5: Simulated current and temperature distributions for a methane reformat-fed SOFC.

A first potential application of the control-oriented model is the development of a PI controller to avoid undesired temperature rise during transient operation. Figure 6 compares voltage response in case of controlled and uncontrolled operation. It emerges how the PI control action on SOFC excess air (see Figure 8) eliminates the dangerous temperature rise (see Figure 7) that could occur without appropriate control strategies. Following the activities tree (see Figure 3) the control oriented approach adopted for the SOFC stack was extended to an entire SOFC-APU system. Particularly, lumped modeling of heat exchangers, post-burner and methane reformer was proposed in [28]. Figure 9 illustrates a first potential application of the computational tool developed in [28]: the optimal design of an SOFC-APU for automotive applications. Particularly, Figure 9 shows both energy and mass flows characterizing SOFC-APU working in correspondence of its nominal operating condition.

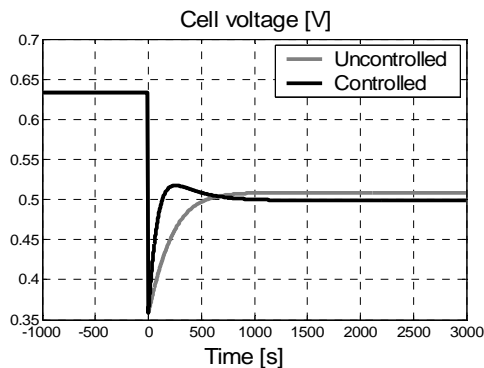

Figure 6: Comparison between voltage responses in controlled and uncontrolled operation.

The model was also used to develop optimal energy management strategies of a hybrid SOFC-APU for heavy-duty trucks. Figure 10 shows the optimal power splitting between battery pack and SOFC under a typical auxiliary load profile. The comparison between fuel cell and engine performance indicates the replacing engine-idling during truck hotel conditions allows saving up to 75 % of equivalent Diesel consumptions.

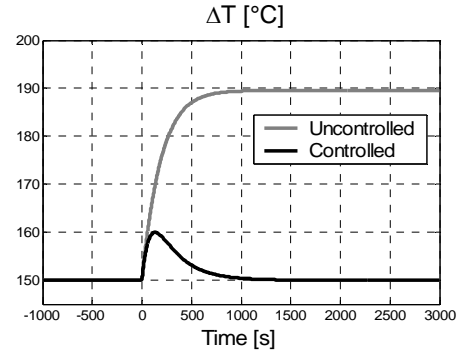

Figure 7: Comparison between temperature responses in controlled and uncontrolled operation.  $T$  is the difference between outlet and inlet temperature.

## 7. Conclusions

The papers reported on modeling methodologies that can be followed to develop control-/diagnostic-oriented models of SOFC cells/stacks. After an overview on the main issues to be addressed to promote SOFC technology, the hierarchical modeling which models development is based on was deeply presented and discussed.

Section 7 summarizes the main applications the modeling structure here proposed was proven to be suitable for. Particularly, control-oriented modeling of SOFC systems may enhance design phase at both cell and stack level, on one hand; on the other, it can significantly contribute to satisfactorily address strategic issues, such as optimal BoP as well as the definition of suited control and diagnostics strategies/architecture.

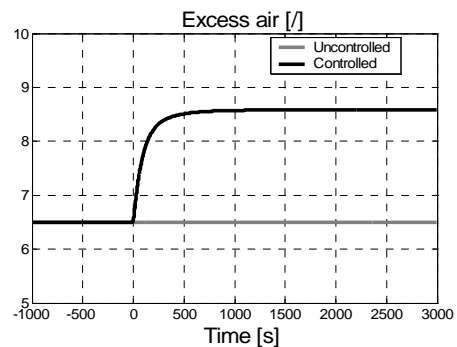

Figure 8: Excess of air in controlled and uncontrolled operation.

## 8. References

- [1] Solid State Energy Conversion Alliance (SECA), 2008, <http://www.netl.doe.gov/technologies/coalpower/fuelcells/seca/>,
- [2] Singhal, S. C., 2002, "Solid oxide fuel cells for stationary, mobile and military applications", *Solid State Ionics*, 152-153, pp. 405–410.



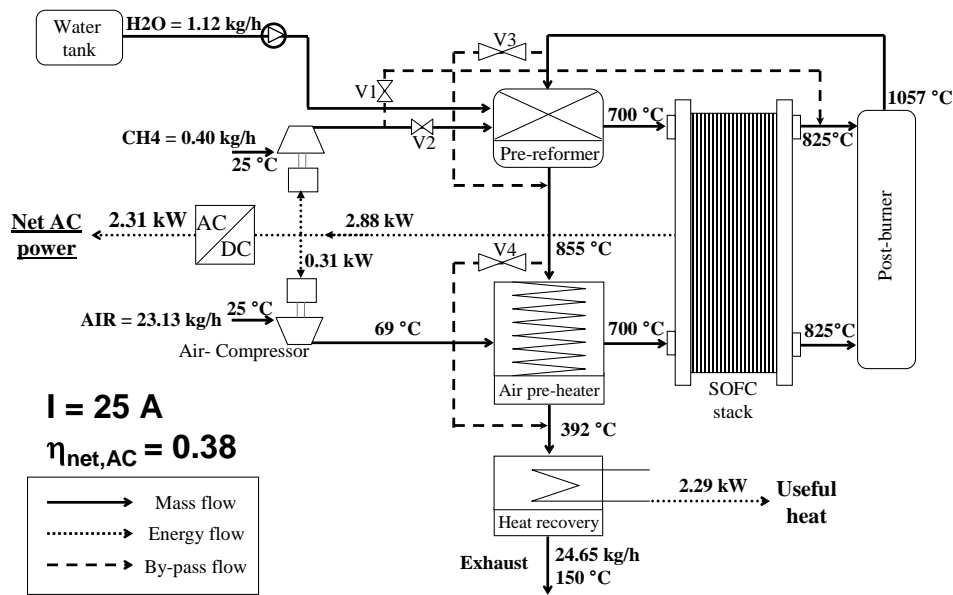

Figure 9: Plant schematic of an SOFC-APU with description of energy and mass flows for the at the nominal operating point (i.e.  $I = 25$  A).

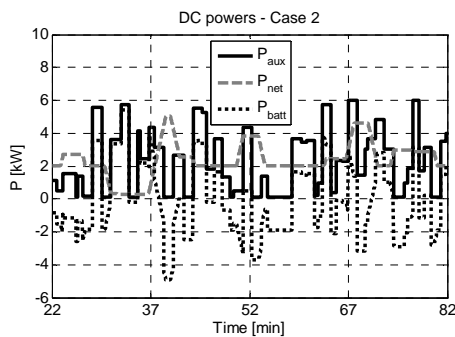

Figure 10: Transient trajectories of power contribution in a controlled hybrid SOFC-APU.

- [3] Braun, R. J., 2002, "Optimal Design and Operation of Solid Oxide Fuel Cell Systems for Small-scale Stationary Applications", Ph.D. Thesis, University of Wisconsin, Madison, WI.
- [4] Topsoe, 2006, "Topsoe Fuel Cell and Wärtsilä Corporation demonstrate operating results", <http://www.topsoe.com/News/PressReleases/2006.aspx>.
- [5] Rosenberg, R., 2008, "FCH JU organisation and programmes", European SOFC stakeholders workshop, November 26-27, Sofia, Bulgaria.
- [6] Moran, M.J., and Shapiro, H.N., 2004, Fundamentals of Engineering Thermodynamics, John Wiley and Sons, Hoboken, NJ (USA), pp. 681-683.
- [7] Chan, S.H., Ho, H.K., and Tian, Y., 2003, "Modeling for part-load operation of solid oxide fuel cell-gas turbine hybrid power plant", Journal of Power Sources, Vol. 114, pp. 213-227.
- [8] Winkler, W., and Lorenz, H., 2002, "Design studies of mobile applications with SOFC-heat engine modules", Journal of Power Sources, Vol. 106, pp. 338-343.
- [9] Ormerod, R.M., 2003, "Solid oxide fuel cells", Chemical Society Review, Vol. 32, pp. 17-28.
- [10] Botti, J.J., Grieve, M.J., and MacBain, J.A., 2005, "Electric Vehicle Range Extension Using an SOFC APU", SAE Paper 2005-01-1172.
- [11] Aguiar, P., Adjiman, C. S., and Brandon, N.P., 2004, "Anode-supported intermediate temperature direct internal reforming solid oxide fuel cell. I: model-based steady-state performance", Journal of Power Sources, Vol.138, pp. 120-136.
- [12] Chick, L. A., Williford, R. E., Stevenson, J. W., Windisch Jr, C. F., and Simner, S. P., 2002, "Experimentally Calibrated, Spreadsheet Based SOFC Unit Cell Performance Model", Proceedings of Fuel Cell Seminar, PNNL-SA-37014, 19-21 November, 2002, Palm Springs, CA.
- [13] Achenbach, E., 1995, "Response of a solid oxide fuel cell to load change", Journal of Power Sources, 57, 105.
- [14] Aguiar, P., Adjiman, C.S., and Brandon, N.P., 2004, "Response of a Planar Intermediate-Temperature Anode-Supported Direct Internal Reforming Solid Oxide Fuel Cell to Load Changes", Proceedings of Escape-14, Symposium dedicated to Prof. Roger W. H. Sargent, May 16-19, 2004, Lisbon, Portugal.
- [15] Sedghisigarchi, K., and Feliachi, A., 2004, "Dynamic and Transient Analysis of Power Distribution Systems with Fuel Cells – Part 1: Fuel-Cell Dynamic Model", IEEE Transactions on Energy Conversion, Vol.19, No. 2, pp. 423-428.

- [16] Sedghisigarchi, K., and Feliachi, A., 2004b, "Dynamic and Transient Analysis of Power Distribution Systems with Fuel Cells – Part 1: Control and Stability Enhancement", *IEEE Transactions on Energy Conversion*, Vol.19, No. 2, pp. 429-434.
- [17] Lu., N., Li, Q., Sun, X., Khaleel, M.A., 2006, "The Modeling of a Standalone Solid-Oxide Fuel Cell Auxiliary Power Unit", *Journal of Power Sources*, Vol. 161, pp. 938–948.
- [18] Lin., P.H., Chiou, C.M., and Wong., C.W., 2006, "Cold Start Dynamics and Control of the SOFC APU for Automotive Applications", *Proceedings of AVEC '06, The 8th International Symposium on Advanced Vehicle Control*, August 20-24, 2006, Taipei, Taiwan.
- [19] Lutsey, N., Wallacd, J., Brodrick, C.J., Dwyer, H.A., and Sperling, D., 2004, "Modeling Stationary Power for Heavy-Duty trucks: Engine Idling vs. Fuel Cell APUs", *SAE paper 2004-01-1479*.
- [20] Lawrence, J., and Boltze, M., 2006, "Auxiliary Power Unit Based on a Solid Oxide Fuel Cell and Fuelled with Diesel", *Journal of Power Sources*, Vol. 154, pp. 479–488.
- [21] Hansen, J.B., Palsson, J., Nielsen, J.U., Christiansen, N., Ramshack, E., Shussler, M., and Prensinger, P., 2005, "Successful Testing of a SOFC Stack for Mobile APU Applications", available at [www.topsoefuelcell.com](http://www.topsoefuelcell.com).
- [22] D. Hissel, M. C. Péra, and J. M. Kauffmann, "Diagnosis of automotive fuel cell power generators," *J. Power Sources*, vol. 128, no. 2, pp. 239–246, 2004.
- [23] C. Nitsche, S. Schroedl, and W. Weiss, "Onboard diagnostics concept for fuel cell vehicles using adaptive modelling," in *Proc. IEEE Intell. Veh. Symp.*, Parma, Italy, 2004, pp. 127–132.
- [24] C. Brunetto, G. Tina, G. Squadrito, and A. Moschetto, "PEMFC diagnostics and modelling by electrochemical impedance spectroscopy," in *Proc. IEEE MELECON Conf.*, Dubrovnik, Croatia, 2004, pp. 1045–1050.
- [25] Rizzoni, G., Josephson, J.R., Soliman, A., Hubert, C., Cantemir, C.G., Dembski, N., Pisu, P., Mikesell, D., Serrao, L., Russell, J., Carroll, M., 2005, "Modeling, simulation, and concept design for hybrid-electric medium-size military trucks", *Journal of Unmanned Ground Vehicle Technology VII, Proceedings of the SPIE*, Volume 5805, pp. 1-12.
- [26] Arsie, I., Di Domenico, A., Pianese, C., Sorrentino, M., 2007, "Modeling and Analysis of Transient Behavior of Polymer Electrolyte Membrane Fuel Cell Hybrid Vehicles", *ASME Transactions, Journal of Fuel Cell Science and Technology* 4: 3. 261-271.
- [27] Sorrentino, M., Pianese, C., Guezennec, Y.G., 2008, "A Hierarchical Modeling Approach to the Simulation and Control of Planar Solid Oxide Fuel Cells", *Journal of Power Sources* 180: 1. 380-392.
- [28] Sorrentino, M., Pianese, C., 2009, "Control Oriented Modeling of SOFC Auxiliary Power Unit for Transportation Applications", scheduled for publication on May 2009 by *ASME Transactions, Journal of Fuel Cell Science and Technology*.